



STOVAX

RIVA2 WOOD & MULTI-FUEL FIRES

A class of its own

Welcome to the Riva2 range of woodburning and multi-fuel fires – an Ecodesign collection of Inset and Freestanding flagship fires from Stovax that expertly blends our inherent need for natural fire with the very latest heating technology.

Encapsulating Stovax's deep-rooted heritage in heating design and engineering, this range delivers high efficiency heat, superior flame visuals, and a sleek centrepiece that will bring years of warmth and fireside ambience.

Designed for a low-emission burn, the Riva2 realises decades of first-class craftsmanship, with state-of-the-art combustion systems and uncompromising style. These fires are built to last and easy to operate, delivering both sophisticated design and performance in equal measure.



*Riva2 50 Freestanding
Ecodesign fire, with
removeable handle in situ,
shown on 120 High Bench*





Contents

- 04 Key features
- 06 Your environment
- 08 Peace of mind

- 10 Inset Fires
- 20 Freestanding Fires

- 30 Technical information
- 34 Exceeding Ecodesign
- 36 Further information
- 38 Also available

See it burning

To experience the Riva2 range's superb flame visuals and elegant styling, view the video at stovax.com/riva2eco



Above: Riva2 55 Inset Ecodesign fire, with Profil XS 3-sided frame. Also shown, Stovax Claremont Limestone mantel.
Cover image: Riva2 66 Ecodesign fire, with removeable handle in situ, and Profil 4-sided frame.

Developed for outstanding performance

The Riva2 precisely balances efficiency, performance and user control to create an Ecodesign and DEFRA exempt solid fuel fire at the forefront of innovation, making an excellent choice for rural and urban homes alike.

Heated air jets

Heated air jets from Cleanburn ports burn hydrocarbons in combustion gases, allowing for a cleaner burn.

Easy-install flue connection

Thanks to an easy-install flue spigot on Inset fires, connection to the flue is simple to secure into position.

Warm air ducting system outlets

Most Riva2 Inset fires offer the opportunity to heat up to two other living spaces using an optional ducting system.

Convected and radiant heat

As well as radiant heat that emanates from the glass and body, cool air is drawn into the convection chamber between the inner and outer skin of the fire, heating as it rises before flowing out of the stove into the room.

Stylish thermal lining system

Designed to both improve efficiency and performance by promoting effective airflow, the stylish lining within Riva2 fires make a statement even when not alight.

Externally operated riddling grate

When burning smokeless mineral fuels on the Riva2 40 multi-fuel model, the external riddling control also serves as the primary air control.

Integrated External Air Connection

Thanks to their built-in air connection from the rear or base, Riva2 fires come ready to be installed with an external air supply without needing an additional bespoke external air kit. See page 32.

Removeable ashpan

All Riva2 models feature a removeable ashpan for easy maintenance.

Airtight door with removeable handle

All Riva2 fires feature an ergonomically designed handle that can be removed from the fire so that it remains cool to touch.

Advanced DualFlow Airwash for ultra-clean glass

Innovative convergent air flow introduced from the top and bottom of the firebox ensures a crystal clear view of the flames.

Smooth Air Controls

Two sliding controls make operation of the primary air (see image left), including Ri-Ignite Boost mode*, and DualFlow Airwash smooth and straightforward.

*See page 5



Ri-Ignite Boost mode



Riva2 fires feature a Ri-Ignite Boost mode, allowing a rapid 'boost' to make it effortless to ignite logs, even from a small ember. Whether you want a lazy flame, or a vivid roar, the Riva2 gives you easy control over your fire, operated via the smooth control.

Quality assured

The Stovax Heating Group is subject to stringent tests and we are proud to be an ISO 9001 and ISO 14001 accredited company, recognised for our continued commitment to technical innovation, high quality products and excellent customer and after-sales care.

Our rigorous quality control system ensures that all our appliances are safety checked and that they comply with the appropriate regulations, with all fires in this brochure bearing the UKCA and CE marks. Similarly, our environmental management systems ensure we work in a sustainable manner, whilst endeavouring to protect the environment by minimising any possible impact from our operations.



We are proud to have won 'Best Stove Product' at the Build It Awards with our exemplary Stovax Riva2 range, and have been recognised as an award-winning manufacturer, for our high-quality products and innovative technology with various other accolades. **Find out more at stovax.com/awards**





Designed for the environment

Ecodesign Plus Performance

We care about our impact on the environment. That's why all models in the Riva2 range meet and even exceed Ecodesign efficiency standards. Ecodesign emission and heating efficiency regulations aim to improve air quality by minimising the level of permitted emissions from woodburning products. This superior range of solid fuel fires therefore all proudly bear the Ecodesign Plus label to help you easily identify their credentials as meeting standards for low emissions.



Natural Heat

When sustainably sourced and burnt on a quality appliance, wood is commonly viewed as a low carbon fuel source for domestic heating, releasing approximately the same amount of carbon into the atmosphere as that absorbed during the growth of a tree.

Choosing one of our high efficiency low emission fires is a great step towards burning responsibly. To ensure your fire provides optimum heating performance, only wood with a low moisture content should be burnt. Seasoned logs should be allowed to dry for at least two years or more to achieve a moisture content between 14-20%, which can be easily checked with a moisture meter.

Good quality dry wood will not only provide a higher heat output than that of freshly felled timber, it will also avoid a build-up of tar in your flue and lower smoke emissions, whilst providing crisp and clear flame visuals. When purchasing seasoned or kiln dried wood, look for the Woodsure "Ready to Burn" certification.



Riva2 40 Freestanding Ecodesign fire with removeable handle in situ, and Walnut-effect Hardwood feet

WIN

THE COST OF YOUR PRODUCT BACK!*

by registering your product online for your free extended warranty. See page 32 for details.

Urban Area Approved

Many town and city homes are located in Smoke Control Areas as designated by the Clean Air Act 1993. Riva2 fires are DEFRA smoke control area exempt as standard, and can be used for the burning of wood in these areas.



High Efficiency

All Riva2 fires have been designed to burn with high thermal efficiency, minimising the loss of heat energy during combustion. Every model in this brochure is subject to European energy labelling standards and all are rated as either A or A+ energy class appliances. Energy class and efficiency information is listed on each product page for easy reference.



Complete peace of mind



Expert Retailer Network

We take great care to ensure that our fires are designed, tested and manufactured to the highest possible quality and safety standards. We are just as concerned to make certain that they are sold and installed correctly so that you enjoy years of pleasure from your purchase. Accordingly, you will find our products are only available from experienced, independent retailers who will be happy to show you a selection of models locally in their showrooms, often fully operational. These independent retailers will discuss your individual requirements both technical (such as sizing the heat output to your room and advising on your chimney system) and visual, and ensure that you select the most appropriate product for your home. They will also be able to advise on, or assist, with the installation process as well as help provide any after-sales support and servicing your appliance may require in the future.

Whilst we encourage our retailers to promote fireplace products and their outlets via the internet, we do not believe suitable levels of customer care and satisfaction can be obtained from purchasing the product only online and we would strongly recommend that you consider this when undertaking your research and making a purchasing decision. Furthermore, please be aware that we do not offer technical support (beyond our statutory responsibilities) to products bought via nationwide online sales, where this support would normally be offered by one of our qualified, independent retailers.



Find your local expert retailer

You can find your nearest retailer by visiting:
stovax.com/retailers

Extended Warranty

When you choose a Stovax Riva2 fire, quality and technology are assured. Accordingly, when you purchase your new fire from a Stovax Expert Retailer they will provide you with a Two Year Warranty. This can then be extended to a Ten Year Warranty provided your fire is registered with Stovax.

See page 37 for further information.



МВАВВАВВА
EXTENDED



Riva2 Inset Fires | Sizes & Frames

Stovax Riva2 inset fires are available in four sizes, from the smallest in the range that can be installed into a standard 22" high x 16" wide British fireplace opening with the chairbrick removed, to the largest in the range that offers an impressive 8.1kW heat output.



	RIVA2 40	RIVA2 50	RIVA2 55	RIVA2 66
Nominal heat output	4.9kW	5.0kW	5.0kW	8.1kW
Heat output range	3.6 - 5.3kW	3.8 - 6.5kW	4.3 - 6kW	5.5 - 9kW
Max. efficiency	80.5%	77.4%	77.1%	76.5%
Energy efficiency class	A+	A	A	A
Woodburning	✓	✓	✓	✓
Multi-fuel	✓	-	-	-
Max. log length	250mm	350mm	350mm	500mm

Figures shown for Riva2 40 are when burning wood fuel. See page 35 for more information on multi-fuel performance. For detailed technical information, please see page 30 onwards.



Profil

Profil XS

Frame options

Available to all Riva2 inset fires, choose from the Profil XS or slightly wider Profil frame for a contemporary finish. Both frames are available in either three-sided or four-sided versions, allowing you to hearth mount your Riva2, or elevate the fire's position for a modern 'hole-in-the-wall' look.

3-Sided and 4-Sided options available for all sizes.







View the video

stovax.com/riva2eco

Riva2 40 Inset Ecodesign fire, with removeable handle in situ, and Profil XS 4-sided frame



RIVA2 40 INSET

Comfortable fit, **outstanding performance**

Smallest in this high efficiency range of solid fuel fires is the Riva2 40 Inset – designed specifically to fit into a standard 22” high x 16” wide British fireplace opening with the chairbrick removed. This allows you to install the fire into an existing opening with less building work, and in some cases even without removing a hearth and mantel already in place.

Riva2 40 fires offer the highest efficiency in the range, boasting an A+ energy rating. This model is also the only fire in the range that offers the ability to burn smokeless fuels, if desired.

Key Features

- Nominal Heat Output: 4.9kW
- Max. Efficiency & Class: 80.5% **A+**
- Flame Viewing Area: 256 x 325mm
- Flue Connection (Internal Diameter): 127mm (5")
- Max. Log Length: 250mm
- Top Exit Flue Connection
- Wood & Multi-Fuel
- Profil & Profil XS, 3-sided & 4-sided frames
- Integrated External Air Connection (see page 32)
- Removeable handle
- Freestanding model available (see page 22)

For detailed technical information, including firebox dimensions, please see page 30 onwards. For multi-fuel performance, see page 34.







 **View the video**
stovax.com/riva2eco

Riva2 50 Inset Ecodesign fire, with Profil XS 4-sided frame

RIVA2 50 INSET

Harmonised lines

The Riva2 50 Inset fire is designed to fit a 22" high fireplace opening with the chairbrick removed, and takes the same clean lines of the smaller 40 into a landscape format fire. Our advanced DualFlow Airwash system keeps the glass ultra-clean, allowing you to immerse yourself in the uninterrupted view of the Riva2's rolling flames.

Further images shown on pages 32 & 36.

Key Features

- Nominal Heat Output: 5.0kW
- Max. Efficiency & Class: 77.4% **A**
- Flame Viewing Area: 396 x 325mm
- Flue Connection (Internal Diameter): 127mm (5")
- Max. Log Length: 350mm
- Top Exit Flue Connection
- Woodburning Version Only
- Profil & Profil XS, 3-sided & 4-sided frames
- Integrated External Air Connection (see page 32)
- Removeable handle
- Warm Air Ducting System Outlets
- Freestanding model available (see page 25)

For detailed technical information, including firebox dimensions, please see page 30 onwards.

Riva2 50 Inset Ecodesign fire with removeable handle in situ, and Profil 3-sided frame



Riva2 55 Inset Ecodesign fire, with removeable handle in situ, and Profil 4-sided frame. Shown with Stovax Professional XQ™ twin wall flue system.



View the video

stovax.com/riva2eco

RIVA2 55 INSET

Picture-perfect flame visuals

With its portrait proportions, and the same modern styling options, the Riva2 55 Inset fire creates an impressive talking point that sleekly frames the drama of the tall flowing flames within. The Riva2 55 can be installed into a fireplace opening that is 915(h) x 915(w) x 400mm(d) (36" h x 36" w x 16" d). Like the rest of the Riva2 range, the 55 offers a high-efficiency performance and comes equipped with an integrated external air connection, ready to take combustion air directly from the exterior of your property.

Further images shown on pages 3 & 11.

Key Features

- Nominal Heat Output: 5.0kW
- Max. Efficiency & Class: 77.1% **A**
- Flame Viewing Area: 396 x 435mm
- Flue Connection (Internal Diameter): 127mm (5")
- Max. Log Length: 350mm
- Top Exit Flue Connection
- Woodburning Version Only
- Profil & Profil XS, 3-sided & 4-sided frames
- Integrated External Air Connection (see page 32)
- Removeable handle
- Warm Air Ducting System Outlets
- Freestanding model available (see page 26)

For detailed technical information, including firebox dimensions, please see page 30 onwards.





Riva2.55 Inset Ecodesign fire with Profil XS 3-sided frame.
Also shown, Stovax Sandringham Limestone mantel.

Riva2 66 Inset Ecodesign fire with removeable handle in situ, and Profil 4-sided frame



RIVA2 66 INSET

Ambience made to last

Largest in the range, and offering a substantial 8.1kW heat output, the Riva2 66 inset fire provides ample warmth and high efficiency uncompromised by style. Suited for a 22" high fireplace opening with the chairbrick removed, the 66 model makes an industrial-chic statement in larger rooms, enhanced by the framing options available.

Featuring the same stylish thermal lining system as the rest of the range, the Riva2 66 makes a beautiful centrepiece, whether or not the fire is alight.

Further images shown on pages 9 & 34.

Key Features

- Nominal Heat Output: 8.1kW
- Max. Efficiency & Class: 76.5% **A**
- Flame Viewing Area: 506 x 325mm
- Flue Connection (Internal Diameter): 127mm (5")
- Max. Log Length: 500mm
- Top Exit Flue Connection
- Woodburning Version Only
- Profil & Profil XS, 3-sided & 4-sided frames
- Integrated External Air Connection (see page 32)
- Removeable handle
- Warm Air Ducting System Outlets
- Freestanding model available (see page 29)

Riva2 66 Inset Ecodesign fire with removeable handle in situ, and Profil XS 3-sided frame

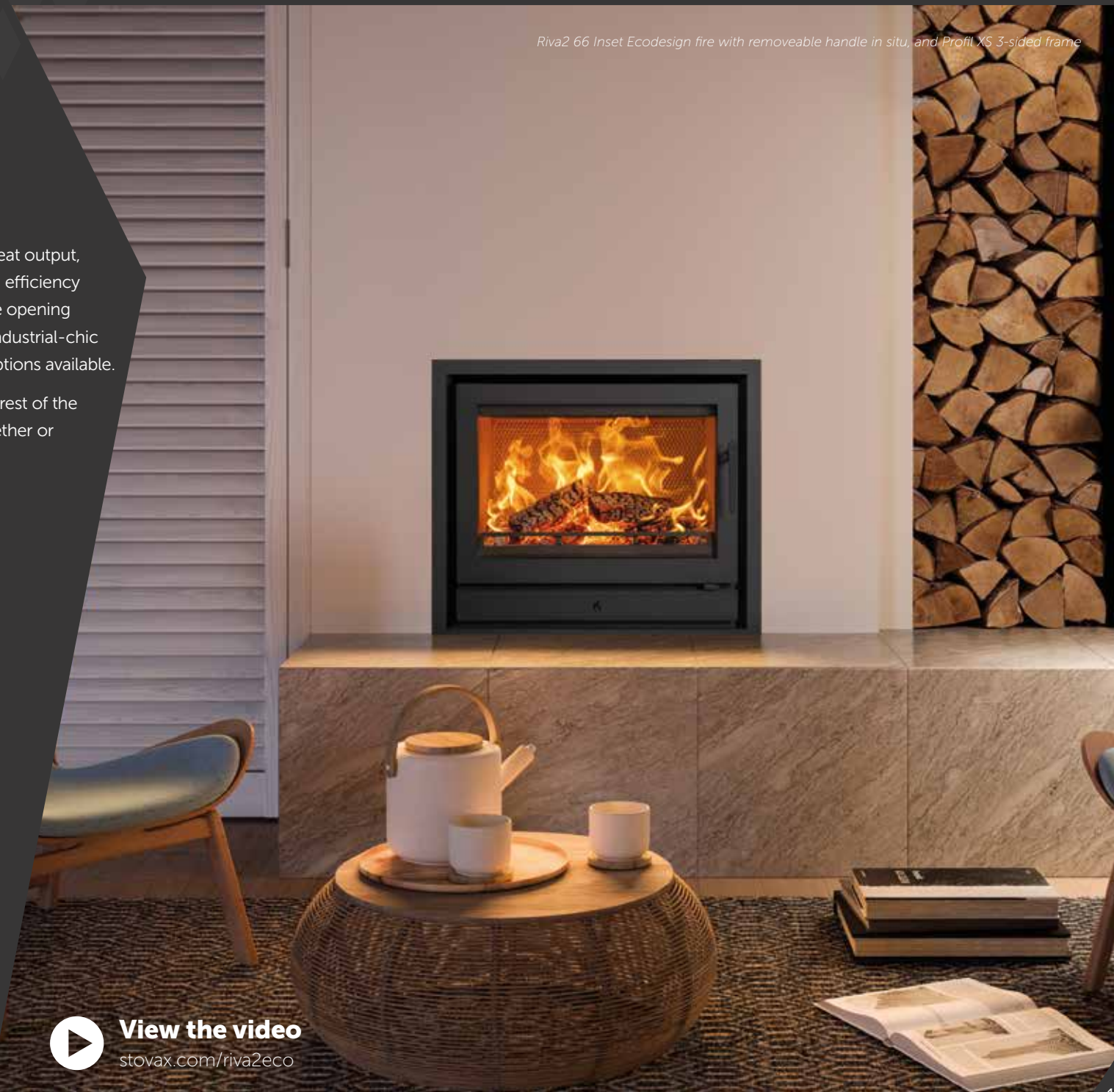

For detailed technical information,
including firebox dimensions, please
see page 30 onwards.



View the video

stovax.com/riva2eco

Riva2 Freestanding Fires

Sizes & Styling Options

The Stovax Riva2 Freestanding range takes the same contemporary styling and high-performance heating as the inset fires, and delivers it within a striking standalone stove collection – from the compact 40, to the larger 66. Across all Freestanding models, the corners are subtly curved – softening the form while keeping all the crisp, clean styling that defines the Riva2 identity.





	RIVA2 40	RIVA2 50	RIVA2 55	RIVA2 66
Nominal heat output	4.9kW	5.0kW	5.0kW	8.1kW
Heat output range	3.6 - 5.3kW	3.8 - 6.5kW	4.3 - 6kW	5.5 - 9kW
Max. efficiency	80.5%	77.4%	77.1%	76.5%
Energy efficiency class	A+	A	A	A
Woodburning	✓	✓	✓	✓
Multi-fuel	✓	-	-	-
Max. log length	250mm	350mm	350mm	500mm
Overall Dimensions* W x H x D	442 x 597 x 372mm	582 x 597 x 372mm	582 x 707 x 372mm	692 x 610 x 372mm



Riva2 66 Freestanding shown with Cast Iron Feet

*Dimensions are without feet or logbox. Figures shown for Riva2 40 are when burning wood fuel. See page 35 for more information on multi-fuel performance. For detailed technical information, please see page 30 onwards.



Cast Iron Feet

Walnut-effect
Hardwood feet

Log Box

Log Box & Feet

Stove Benches
See page 33

Mounting & Styling Options

Each Riva2 Freestanding fire is compatible with our contemporary steel stove benches (see page 33), offering a sleek and modern alternative to a hearth-mounted installation by raising the stove for enhanced presence. Alternatively, log boxes elevate the Riva2 for greater visual impact and a practical solution for storing wood.

Also available to all Riva2 Freestanding fires are a choice of additional styling options. Cast iron or wooden feet in a walnut finish lend a gentle nod towards traditional stove design. The feet can also be paired with the optional log boxes, if desired.



Riva2 40 Freestanding Ecodesign fire,
shown on 120 Low Bench



RIVA2 40 FREESTANDING

Compact with character

Compact yet powerful, the Riva2 40 Freestanding fire brings high-efficiency heating to smaller spaces without compromising on style. Like the inset model, it boasts an A+ energy rating and offers the versatility to burn both wood and smokeless fuels - making it an ideal choice for urban and countryside homes alike.

Complementing the subtle curvature of its silhouette, optional elegant wooden or industrial-chic cast feet allow you to tailor the stove's look to your décor, or alternatively, a practical log store base can be selected for added convenience and visual appeal.

Further images shown on pages 7, 37 & Back Cover.

Key Features

- Nominal Heat Output: 4.9kW
- Max. Efficiency & Class: 80.5% **A+**
- Flame Viewing Area: 256 x 325mm
- Flue Connection (Internal Diameter): 127mm (5")
- Max. Log Length: 250mm
- Top Exit Flue Connection
- Wood & Multi-Fuel
- Integrated External Air Connection (see page 32)
- Removeable handle
- Optional wooden and cast feet
- Optional log box
- Stove bench compatible (see page 33)
- Inset model available (see page 12)
- 12mm hearth compatible*

**Subject to official listing*

For detailed technical information, including firebox dimensions, please see page 30 onwards. For multi-fuel performance, see page 35.



View the video

stovax.com/riva2eco





Riva2 50 Freestanding Ecodesign fire with removeable handle in situ, and Walnut-effect Hardwood Feet



View the video

stovax.com/riva2eco

RIVA2 50 FREESTANDING

Elegant geometry

Blending sleek, modern design with powerful performance, the Riva2 50 Freestanding brings the signature clean lines of the collection into a versatile landscape format.

The advanced DualFlow Airwash system ensures a crystal-clear view of the rolling flames, so you can enjoy an uninterrupted display of firelight whether the stove is burning brightly or resting as a stylish statement piece.

Delivering high-efficiency heat, this freestanding model makes a visual impact, and can be paired with any of the Riva2 Freestanding styling options – from a choice of feet to a complementary log store base. Elevate the stove further by mounting onto one of our sophisticated, yet practical, steel stove benches.

Further image shown on page 2.

Key Features

- Nominal Heat Output: 5.0kW
- Max. Efficiency & Class: 77.4% **A**
- Flame Viewing Area: 396 x 325mm
- Flue Connection (Internal Diameter): 127mm (5")
- Max. Log Length: 350mm
- Top Exit Flue Connection
- Woodburning Version Only
- Integrated External Air Connection (see page 32)
- Removeable handle
- Optional wooden and cast feet
- Optional log box
- Stove bench compatible (see page 33)
- Inset model available (see page 15)
- 12mm hearth compatible*

**Subject to official listing*

For detailed technical information, including firebox dimensions, please see page 30 onwards.

Riva2 50 Freestanding Ecodesign fire with removeable handle in situ, and optional Log Box



Riva2 55 Freestanding Ecodesign
fire in Claremont Limestone mantel



RIVA2 55 FREESTANDING

Enduring presence

With its elegant portrait proportions, the Riva2 55 Freestanding commands attention as a stunning centrepiece, perfectly showcasing the tall, flowing flames within.

Like the entire Riva2 range, it features an advanced thermal lining system and comes equipped with an integrated external air connection, enabling direct combustion air supply from outside your home for improved efficiency and comfort.

Enjoy the drama of contemporary flames with the freedom and style of a freestanding stove.

Key Features

- Nominal Heat Output: 5.0kW
- Max. Efficiency & Class: 77.1% **A**
- Flame Viewing Area: 396 x 435mm
- Flue Connection (Internal Diameter): 127mm (5")
- Max. Log Length: 350mm
- Top Exit Flue Connection
- Woodburning Version Only
- Integrated External Air Connection (see page 32)
- Removeable handle
- Optional wooden and cast feet
- Optional log box
- Stove bench compatible (see page 33)
- Inset model available (see page 16)
- 12mm hearth compatible

**Subject to official listing*

For detailed technical information, including firebox dimensions, please see page 30 onwards.



View the video

stovax.com/riva2eco



Riva2 55 Freestanding Ecodesign fire with optional Log Box



RIVA2 66 FREESTANDING

Design that **commands**

Standing as an architectural feature with powerful heating performance, the Riva2 66 Freestanding creates a stunning focal point. It delivers an impressive 8.1kW output, making it perfect for warming larger rooms such as open plan spaces, while retaining the same Ecodesign performance as the rest of the collection.

Enjoy all the impact of industrial-chic design with the freedom to position your stove where you need it. Furthermore, personalise its look with one of the various styling options – from a choice of feet finishes, to an impressive and practical log store base that elevates the rolling flame visuals.

Further images shown on pages 21 & 33.

Key Features

- Nominal Heat Output: 8.1kW
- Max. Efficiency & Class: 76.5% **A**
- Flame Viewing Area: 506 x 325mm
- Flue Connection (Internal Diameter): 127mm (5")
- Max. Log Length: 500mm
- Top Exit Flue Connection
- Woodburning Version Only
- Integrated External Air Connection (see page 32)
- Removeable handle
- Optional wooden and cast feet
- Optional log box
- Stove bench compatible (see page 33)
- Inset model available (see page 19)
- 12mm hearth compatible*

*Subject to official listing

For detailed technical information, including firebox dimensions, please see page 30 onwards.



View the video

stovax.com/riva2eco

Riva2 66 Freestanding Ecodesign fire with optional Log Box and Walnut-effect Hardwood Feet

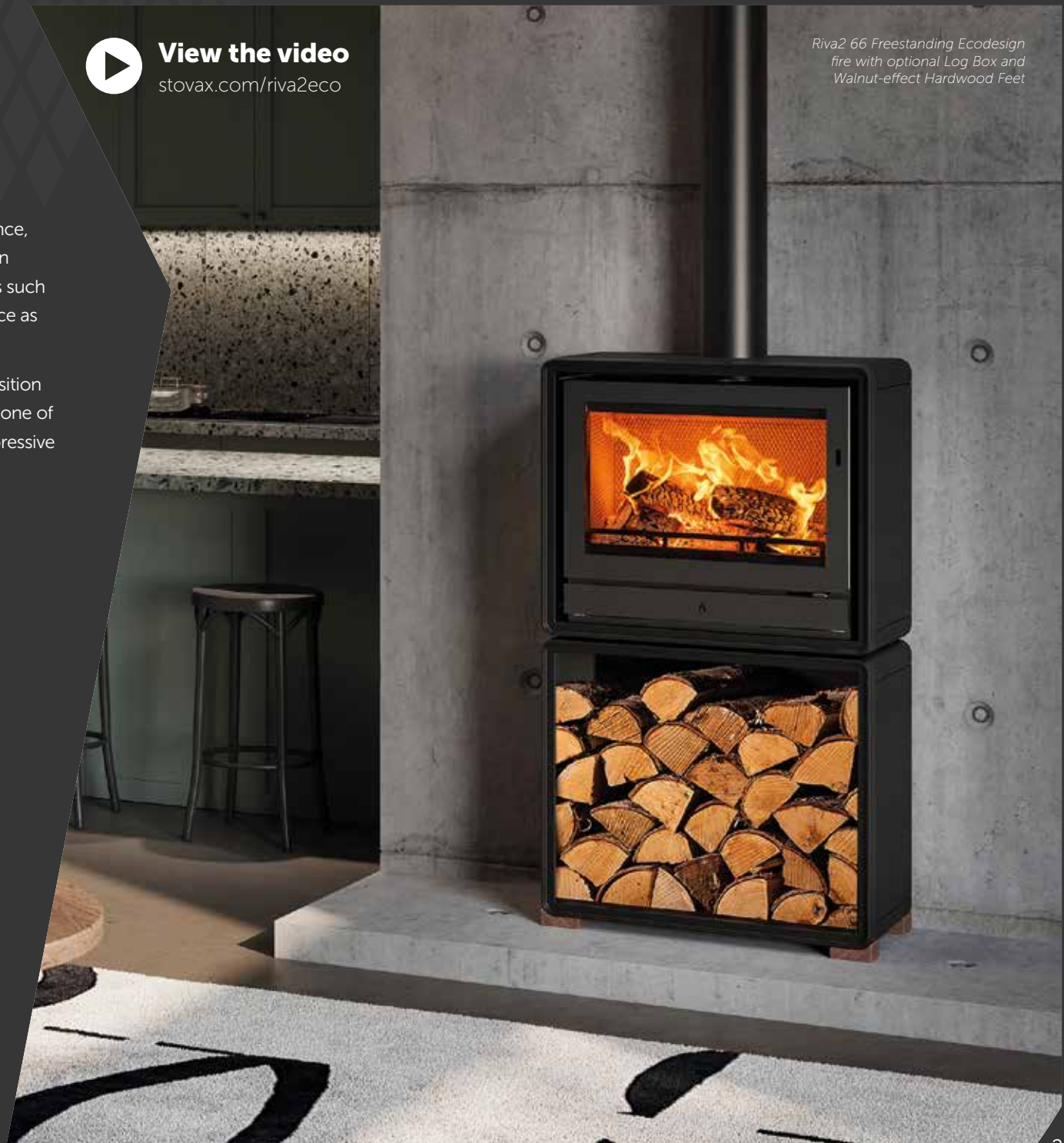

Technical information

Riva2 firebox dimensions (mm)

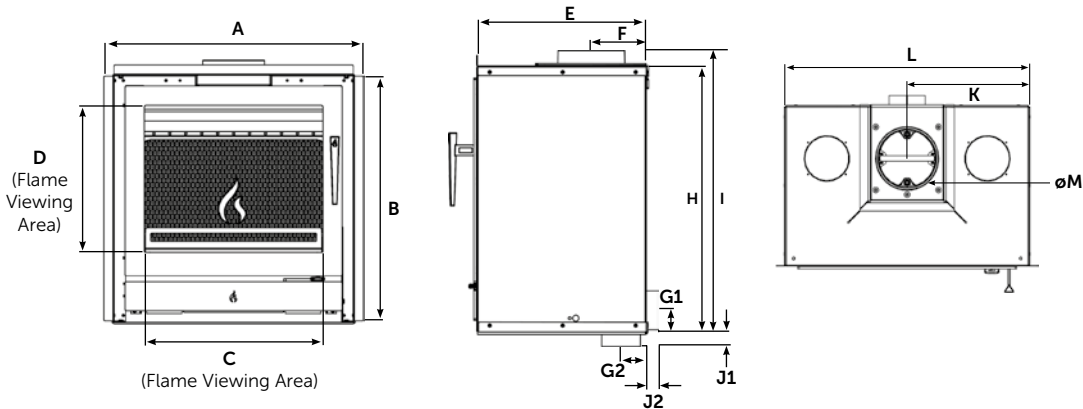

	RIVA2 40	RIVA2 50	RIVA2 55	RIVA2 66
A	436	576	576	686
B	571.5	571.5	681.5	571.5
C	256	396	396	506
D	325	325	435	325
E#	350	350	350	350
F	117.5	117.5	117.5	117.5
G1	49	49	49	49
G2	47.5	47.5	47.5	47.5
H	550	550	660	550
I	582	582	692	582
J1	21.5	21.5	21.5	21.5
J2	20	20	20	20
K	200	270	270	325
L	400	540	540	650
M	127	127	127	127

Please note the minimum distance to combustibles is 150mm from the sides at the front of the appliance, and 500mm from the top of the appliance. For full details, please refer to the instruction manual.

Installation and servicing access is required for the warm air ducting kit.**

Information & product codes

Product Code	Description	Heat Output	Fuel Type	Efficiency	Energy Efficiency Class
323-568	✓ Riva2 40 Inset	4.9kW	Wood & Multi-fuel	80.5%*	A+
323-325	✓ Riva2 50 Inset	5.0kW	Wood	77.4%	A
323-371	✓ Riva2 55 Inset	5.0kW	Wood	77.1%	A
323-386	✓ Riva2 66 Inset	8.1kW	Wood	76.5%	A

✓ These models are approved for use in Smoke Control Areas as standard.

8572 Warm Air Ducting Kit**

998-080 Optional External Air Pipe – 80mm (Suitable for all Riva2 fires)

Riva2 Frame Dimensions (mm)

Product Code	Description	Width	Height
323-801	Riva2 40 Profil XS 3-sided Frame	444	575
323-805	Riva2 40 Profil 3-sided Frame	492	599
323-820	Riva2 40 Profil XS 4-sided Frame	444	596.5
323-829	Riva2 40 Profil 4-sided Frame	492	644.5
323-849	Riva2 50 Profil XS 3-sided Frame	584	575
323-859	Riva2 50 Profil 3-sided Frame	632	599
323-876	Riva2 50 Profil XS 4-sided Frame	584	596.5
323-884	Riva2 50 Profil 4-sided Frame	632	644.5
323-902	Riva2 55 Profil XS 3-sided Frame	584	685
323-908	Riva2 55 Profil 3-sided Frame	632	709
323-924	Riva2 55 Profil XS 4-sided Frame	584	706.5
323-931	Riva2 55 Profil 4-sided Frame	632	754.5
323-946	Riva2 60 Profil XS 3-sided Frame	694	575
323-953	Riva2 60 Profil 3-sided Frame	742	599
323-967	Riva2 60 Profil XS 4-sided Frame	694	596.5
323-976	Riva2 60 Profil 4-sided Frame	742	644.5

#If the direct external air spigot is fitted facing the rear, the depth of the appliance becomes 379mm.

*82.6% when burning smokeless mineral fuel.

**Warm air ducting system not applicable to Riva2 40 Inset models or Riva2 Freestanding models.

An approved competent person of solid fuel installations should undertake a site survey prior to purchase and must install any Stovax stove or fire. Your Stovax retailer will be able to advise on this. The above information is to assist you in your choice of a suitable Stovax Riva2 fire. It is not intended to be all the information required to install your fire or stove; this can be obtained from your local Stovax retailer or you can view/download the relevant full installation instructions from the Stovax website at stovax.com

Riva2 Freestanding dimensions (mm)

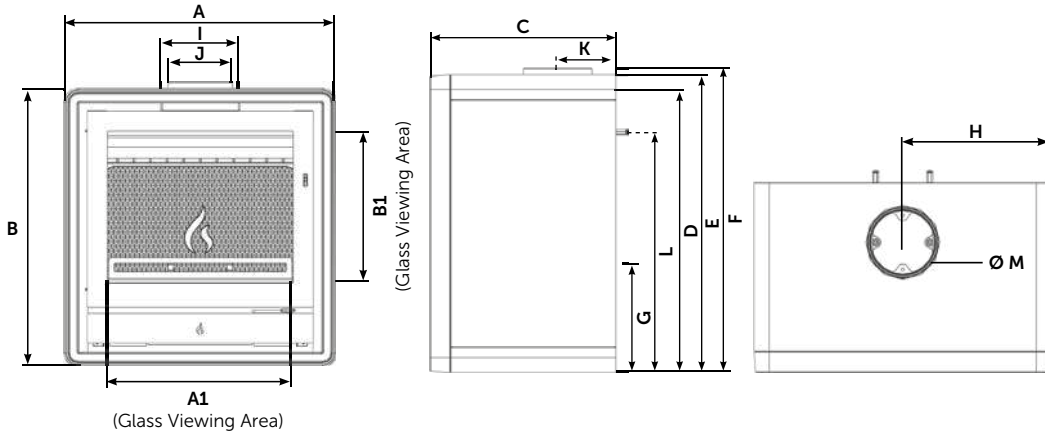

	RIVA2 40	RIVA2 50	RIVA2 55	RIVA2 66
A	442	582	582	692
A1	253	396	396	506
B	597	597	707	610
B1	319	325	435	420
C	372	372	372	372
D	567	567	678	537
E	597	597	707	597
F	601	610	714	610
G	72	70	74	66
H	221	291	291	346
I	137	137	137	137
J	135	135	135	135
K	117	117	117	118
L	482	482	592	482
M	140	140	140	140

Please note the minimum distance to combustibles is 150mm from the rear of the appliance, 250mm from the sides of the appliance, and 500mm from the top of the appliance. For full details, please refer to the instruction manual.

*82.6% when burning smokeless mineral fuel.

An approved competent person of solid fuel installations should undertake a site survey prior to purchase and must install any Stovax stove or fire. Your Stovax retailer will be able to advise on this. The above information is to assist you in your choice of a suitable Stovax Riva2 fire. It is not intended to be all the information required to install your fire or stove; this can be obtained from your local Stovax retailer or you can view/download the relevant full installation instructions from the Stovax website at stovax.com

Log Box Dimensions

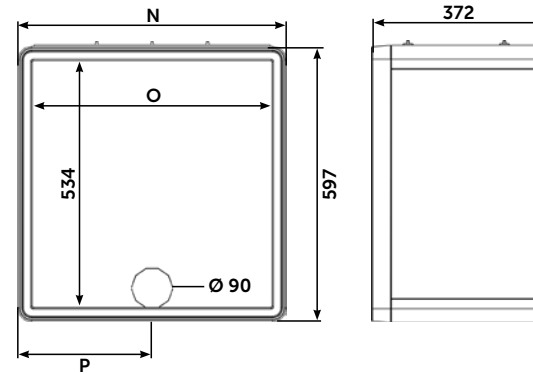

Feet Dimensions

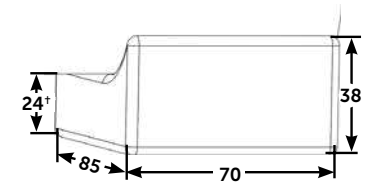

*Feet increase the overall height by 24mm

	RIVA2 40	RIVA2 50	RIVA2 55	RIVA2 66
N	442	582	582	692
O	379	519	519	629
P	221	291	291	346

Information & product codes

Product Code	Description	Heat Output	Fuel Type	Efficiency	Energy Efficiency Class
723-206	Riva2 40 Freestanding	4.9kW	Wood & Multi-fuel	80.5%*	A+
723-214	Riva2 50 Freestanding	5.0kW	Wood	77.4%	A
723-221	Riva2 55 Freestanding	5.0kW	Wood	77.1%	A
723-235	Riva2 66 Freestanding	8.1kW	Wood	76.5%	A

✔ These models are approved for use in Smoke Control Areas as standard.

998-080 | Optional External Air Pipe – 80mm (Suitable for all Riva2 fires)

Optional accessories for freestanding models

Product Code	Description
723-808	Riva2 40 Log Box
723-816	Riva2 50 & 55 Log Box
723-824	Riva2 66 Log Box
723-833	Riva2 Freestanding Cast Iron Feet
723-840	Riva2 Freestanding Walnut-effect Hardwood Feet

Technical information

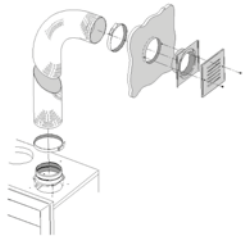

Warm Air Ducting Kit

The warm air ducting kit includes two 3 metre lengths of flexible ducting, allows you to heat up to two other living spaces. All Riva2 inset models except for the 40 have two ports for this kit, providing heat for up to two additional rooms.

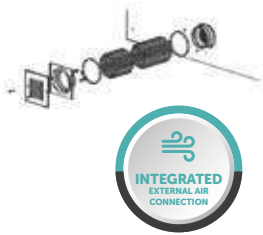

Integrated External Air Connection

Riva2 fires come ready to be installed with an external air supply without needing an additional bespoke external air kit. Thanks to their built-in external air connection from the rear or base, all that is needed for these fires to take combustion air from the outside of the property is to be connected to an external air pipe.

An optional external air pipe can be selected and is compatible with all Riva2 fires. See page 30 & 31 for product code details.



Stovax's Companion Log Holders

Enhance your hearth with Stovax's Black Steel Log Holders, where sleek aesthetics meet everyday practicality. Available in a range of sizes, these holders offer a stylish way to keep your firewood neatly organised. Crafted from robust steel with a Matt Black finish, they ensure lasting durability while adding a sophisticated touch to both traditional and modern interiors. Each design maximises storage capacity without taking up excessive space, making them an ideal choice for rooms of any size or layout.



[View the video](https://stovax.com/riva2eco)
stovax.com/riva2eco

Riva2 50 Ecodesign fire with removeable handle in situ, and Profil 4-sided frame with Ceramic Wood Effect Beam.

WIN THE COST OF YOUR PRODUCT BACK!*



For further home inspiration you can view real life installations at our [Customer Showcase page](#) and share your thoughts and photos of your new stove or fire installation to enter our draw!

- We will publish your entry on our Customer Showcase
- You will be entered into a draw for the chance to win the cost of your product back.
- **Gain a second entry** by registering your product online for your free extended warranty at gazco.com/registration



"Really happy with the stove. I still can't believe it!"

View real life installations and submit your review at: gazco.com/customershowcase

*Terms and conditions apply. See online for details.

Steel Benches



45 High

81 High

100 High

120 High



45 Low

100 Low

120 Low



140 High

180 High



140 Low

180 Low

Product Code	Bench	Width (mm)	Height (mm)	Depth (mm)
RVACLB45BHT	45 Low bench	450	250	420
RVACB45BHT	45 High bench	450	350	420
RVACB81BHT	81 High Bench	809	350	420
RVACLB100BHT	100 Low bench	1000	350	420
RVACB100BHT	100 High bench	1000	350	420
RVACLB120BHT	120 Low bench	1200	250	420
RVACB120BHT	120 High bench	1200	350	420
RVACLB140BHT	140 Low bench	1400	250	420
RVACB140BHT	140 High bench	1400	350	420
RVACLB180BHT	180 Low bench	1800	250	420
RVACB180BHT	180 High bench	1800	350	420

Riva2 66 Freestanding
Ecodesign fire with removeable
handle in situ, shown on 120
High Bench



◇ When storing logs under stove benches Stovax advise this should be offset to one side and not directly beneath the stove's position. If placing beneath the stove there should be a minimum 50mm air gap above logs.



View the video

stovax.com/riva2eco



Exceeding ecodesign

We're proud that all Riva2 Inset and Freestanding fires exceed stringent Ecodesign regulations and limits.



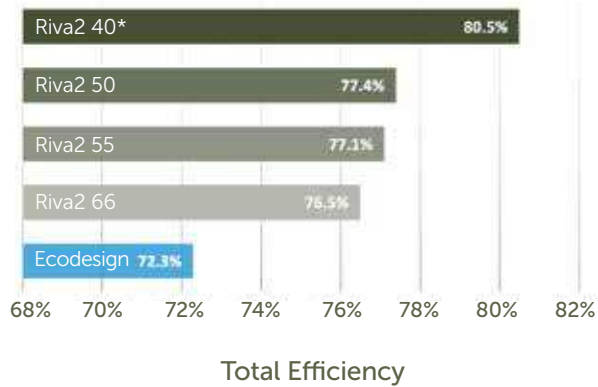

Total Efficiency - %

Balancing a fire's efficiency with cleanliness of burning is a precise science, requiring expert craftsmanship and meticulous testing. All Riva2 models focus on delivering the cleanest burn possible whilst still surpassing the 2022 Ecodesign Efficiency target of 72.3%.
 *82.6% when burning smokeless mineral fuel.

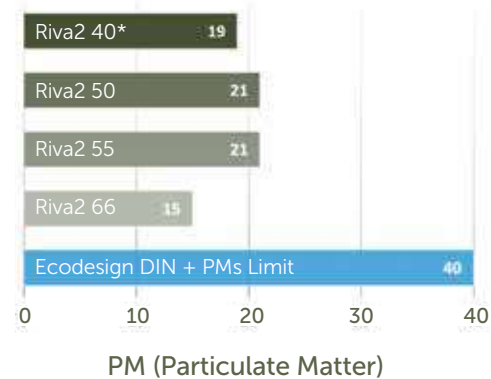

PM (Particulate Matter) mg/Nm³

Ecodesign emission levels for PMs are much tighter than those previously permitted for smokeless zones. Riva2 models burn well below PM targets.
 *12 when burning smokeless mineral fuel.

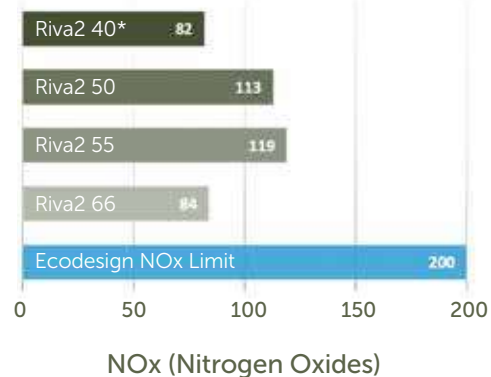

NOx (Nitrogen Oxides) mg/Nm³

Nitrogen oxides affect air quality and are an emission requirement under Ecodesign. All models in the Riva2 range demonstrate NOx emissions so low, they are well below the amount permitted by 2022 limits, demonstrating the Riva2 range's extraordinary burning performance.
 *98 when burning smokeless mineral fuel.

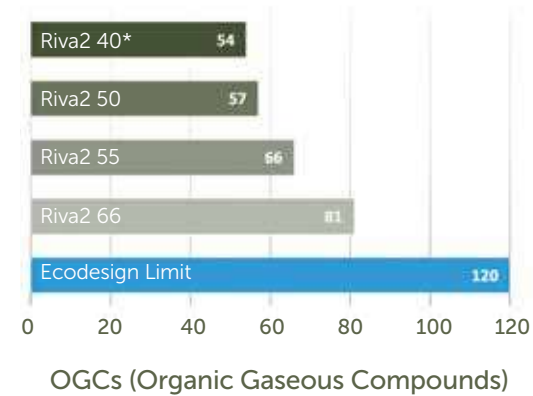

OGCs (Organic Gaseous Compounds) mg/Nm³

OGCs are also an important requirement of the 2022 Ecodesign standard. And all models in the Riva2 range fall well below these exacting emission targets.
 *47 when burning smokeless mineral fuel.

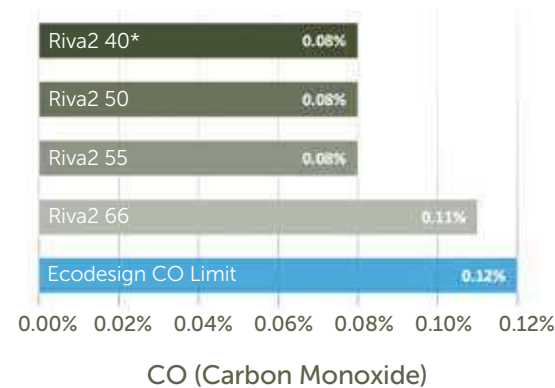

CO (Carbon Monoxide) % @ 13% O₂

Ecodesign limits are set to dramatically reduce the current UK Carbon Monoxide emission limits by a massive 88%, from 1% @ 13% O₂ to 0.12%. All Riva2 models meet this stringent standard.
 *0.06% when burning smokeless mineral fuel.

Energy Efficiency Rating

The entire Riva2 collection burns with high thermal efficiency. All models in the range are subject to European energy labelling standards and are rated as either A or A+ energy class appliances. For individual product information, see page 20.





Further information

*Riva2 50 Ecodesign fire, with
removeable handle in situ,
and Profil 4-sided frame*

Photography & Installation

Due to variations in studio lighting and printing inks, the finishes/colours of fires illustrated in this brochure may differ slightly from actual models. Before purchasing, please ask your retailer to show you finish/colour samples.

All of the flame pictures shown in this brochure are taken from real fires. Please note however that flame pictures will vary depending on the exact fuel used, flue conditions and surrounding geographical features. Given that building regulations are subject to constant change, some of the photography in this brochure may not comply with the requirements of the latest building regulations and you should always check your proposed installation arrangement with your trained installer before proceeding.

When designing your own installation, please also observe the minimum distance to combustible materials as stated in the installation instructions.

Stovax pursues a policy of continuous product improvement, therefore, whilst our products are correct at the time of the photography, we reserve the right to make alterations and amendments. Exact product details should be discussed with your retailer at the time of purchase.

The 'Nominal' heat output is to be used for calculating the ventilation provision as required by ADJ Building Regulations and for calculating its suitability for heating the size of room it will be fitted into. The heat output 'Range' is to be used as a guide only as the maximum and minimum performance will depend on local conditions such as flue pull, fuel quality and the way in which the product is used.

Servicing and Support

To keep your Riva2 looking and performing at its best, it must be serviced annually. This service must be undertaken by an appropriately qualified individual and your retailer can organise this for you. Alternatively, Stovax offer a manufacturers premium service with our friendly team of qualified engineers which can be booked at www.stovax.com/support.



Important Safety Information

Please note that all parts of these fires, particularly the glass panel in the door, become extremely hot during operation and can result in serious injury and burns if touched. It is therefore recommended that a fireguard complying with the current version of BS 8423 is used in the presence of young children, the elderly or infirm. In addition, by law all installations also require a Carbon Monoxide monitor (such as product code 3045 available from Stovax).

Extended Warranty

When you choose a Stovax Riva2 fire, quality and technology are assured. Accordingly, when you purchase your new fire from a Stovax Expert Retailer they will provide you with a Two Year Warranty. This can then be extended to a Ten Year Warranty provided your fire is registered with Stovax.

When you register your fire, you will also be automatically entered into a prize draw where you can win back the cost of your product. (See page 21).

Further details of this warranty and terms & conditions are available to view on stovax.com

Professional XQ™ Chimney Systems

Stovax also offers a comprehensive range of stove & fireplace chimney systems, the Stovax Professional XQ™ collection. Made from 304L grade stainless steel for a durable outer finish, the fully sealed components offer watertight protection for the insulation within. With innovative decorative options, the ability to specify a colour for your system and with a host of technical advancements such as their Twist-Lock system, the Professional XQ™ range provides an attractive, versatile and reliable solution for your flue system. Furthermore, the Professional XQ™ range carries a 10 year conditional warranty offering complete peace of mind.

For further information, please speak to your retailer or visit stovax.com/chimneysystems.



 **View the video**
stovax.com/riva2eco

Also available



Contemporary and traditional stoves and fires

In addition to the selection of fires shown in this brochure, Stovax offers a host of beautiful cassette and freestanding fires in their expansive solid fuel collection, along with a variety of traditional and contemporary stoves – all of which are covered in separate dedicated brochures. If you are looking for a more landscape wide-format fire, the Stovax Studio and Studio Air ranges offer sizes and styling options to suit many different interior preferences for your next home project.

View the brochures online at:
stovax.com/brochures



Stovax Studio 3 Ecodesign Profil



Stovax Studio Air 2 Freestanding with White decorative trim

Onyx Avanti 190RW with optional Logscape Real Woodland Log Set, installed as a two-sided corner fire



Gazco eStudio 165R with log-effect.

Instant heat and ultimate convenience

The Stovax Heating Group is proud to offer a vast portfolio of gas and electric models that deliver superb flame visuals and breath-taking realism that can be controlled from the comfort of your favourite chair.

From our luxury Onyx Avanti electric fire collection, to the versatility of the Gazco eStudio or eReflex ranges, our electric portfolio can be enjoyed with or without the heat for year-round ambience.

Alternatively, the Gazco Riva2 gas collection offers a host of contemporary and traditional styles suited for homes with or without a chimney, to suit your personal tastes and requirements.

For more information, visit gazco.com, or speak to your local retailer.



Have you considered gas and electric?

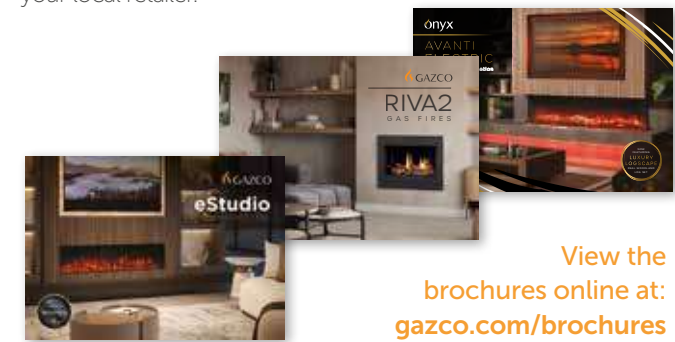

View the brochures online at:
gazco.com/brochures



Riva2 55 Ecodesign fire with removeable handle in situ, and Profil 3-sided frame. Also shown, Stovax Grafton stone mantel.



Riva2 40 Freestanding Ecodesign fire with removeable handle in situ, shown on 120 High Bench.



Stovax Gazco Ltd, Spitfire Avenue, Skypark, Clyst Honiton, Exeter, EX5 2FR

Trade Sales: Tel: 01392 474000
Email: info@stovax.com

stovax.com



Find Your Local Expert Retailer

You can find your nearest retailer by visiting:
stovax.com/retailers



Stovax gratefully acknowledges the assistance of the following companies with photographic settings:

- www.johnlewis.com; www.originalstyle.com; www.furniturevillage.com;
- www.sofarooms.co.uk; www.habitat.co.uk; www.amtico.com;
- www.graceandgloryhome.co.uk; www.loaf.com; www.theorangetree.co.uk;
- www.tomraffield.com; www.industville.co.uk; www.amoslighting.co.uk;
- www.chunkymonkeyfurniture.co.uk; www.desenio.com; www.bricktilecompany.com;
- www.wallsandfloors.com; www.dfs.co.uk; www.andrewmartin.co.uk

Your Stovax stockist:

STXRIVA2 0825

